

CALOMA

RUA; JOÃO ALOYSIO ALGAYER; 6601
B. LOMBA GRANDE, N. HAMBURGO - RS
FONE (051) 3587-3933

REF; 7032

INSTRUÇÕES DE MONTAGEM

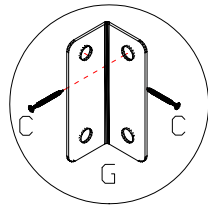
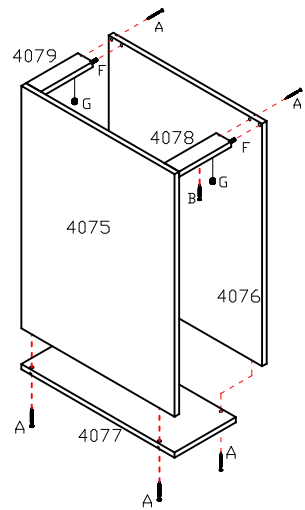

4075-LATERAL ESQUERDA.
4076-LATERAL DIREITA.
4077-BASE.
4078-TRAVESSA FRONTAL.
4079-TRAVESSA TRASEIRA.
4080-RODAPÉ FRONTAL.
4081-RODAPÉ TRASEIRO.
4082-RODAPÉ LATERAL.
4083-TOALHEIRO.
4084-ENCOSTO.

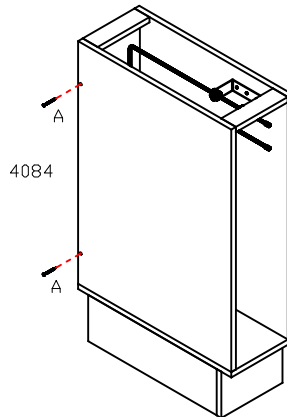
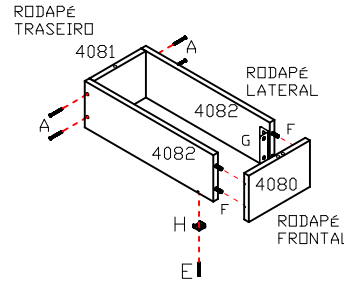

TAMPO VENDIDO SEPARADAMENTE

O RODAPÉ DEVE SER CENTRALIZADO NO MÓVEL ANTES DE PARAFUSAR









APERTAR TODOS OS PARAFUSOS ATÉ A METADE, E SÓ DEPOIS DE PONTAR TODOS DAR O APERTO FINAL.

USAR ESTA FURAÇÃO SE O CLIENTE OPTAR EM POR PÉ, QUE SÃO VENDIDOS SEPARADAMENTE.

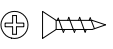
OBS;
COLAR O TAPA FURO ADESIVO SÓ DEPOIS QUE TODOS OS MÓDULOS DA COZINHA ESTIVER UNIDOS, PARA NÃO FALTAR NO FECHAMENTO.

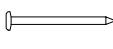
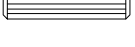
ATENÇÃO MONTADOR;
SE O CLIENTE OBTAR EM POR PEDRA COMO TAMPO, DEVE-SE PARAFUSAR O TOALHEIRO NA LATERAL E ANTES DE MONTAR O MÓVEL.

FERRAGEM QT

FERRAGEM	QT
A  4,5x50	20
B  4,0x35	02
C  4,0x16	11
D  PARAFUSO UNIÃO	02
E  10x10	04
F  CAVILHA 6,0x30	08
G  CANTONEIRA DE GAVETA	06
H  SAPATA PLÁSTICA	04
I  PORCA CILÍNDRICA	04
J  TAPA FURO ADESIVO	04

